

立體搖擺座檯扇 3D twister desk fan

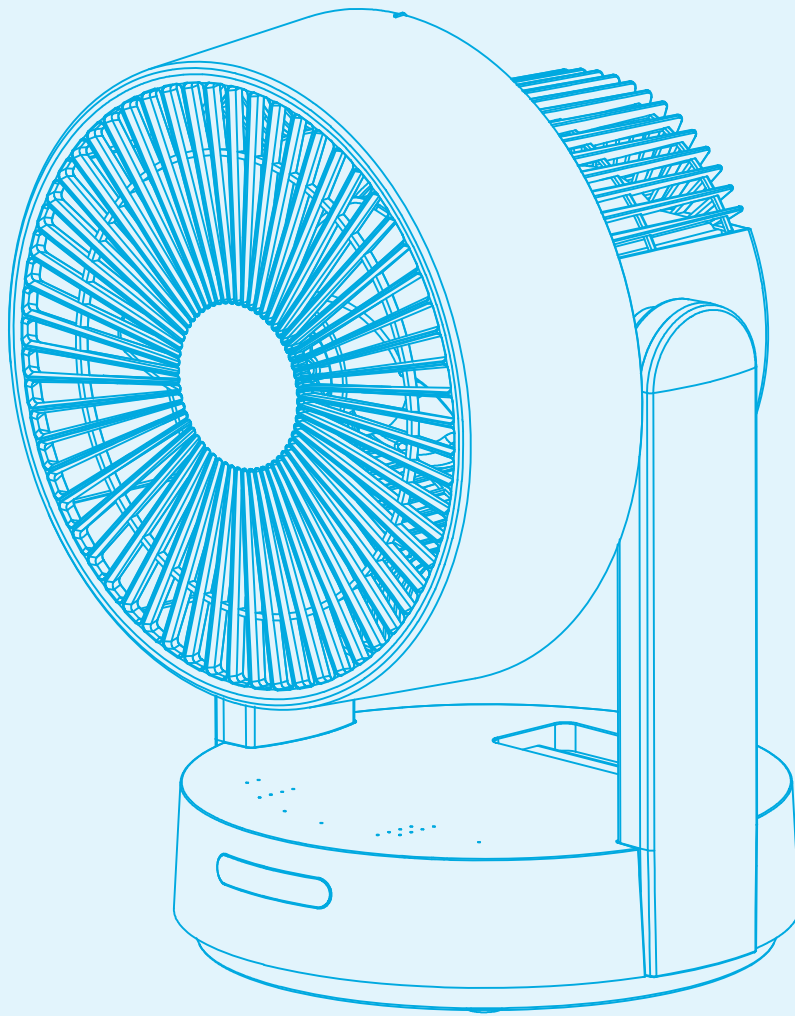

DF1525 使用說明書 INSTRUCTION MANUAL

*使用風扇前，請先細閱使用說明，並請妥善保存以便將來翻閱。

***本說明書可於本公司網站下載 www.origin.hk。

*Read all instructions carefully before using the FAN, and keep this instruction for future reference when necessary.

***This instruction manual can be acquired at www.origin.hk.

- 使用本風扇前，請先細閱使用說明。

Read all instructions carefully before using the Fan.

- 必須按照使用說明指示操作本風扇，否則可能引致產品損壞、短路、火警或人命損傷。

Use this Fan only as described in this manual. Any other use not recommended by the manufacturer may casue fire, electrical shock or injury to persons.

- 打開包裝，檢查風扇。如發現產品有損壞，請勿使用及即時聯絡供應商。

Open the package and ensure that the Fan is undamaged. In case of doubt do not use the FAN Cooler and contact your supplier.

- 包裝物料並非玩具，不可讓小孩玩耍。

Do not let children play parts of package.

- 使用風扇前，請確定規格標貼上所示的額定電壓與當地供電電壓相同。如有疑問可向供應商查詢。

Before using the Fan, check if the voltage marked on the rating label corresponds to the mains at your home.

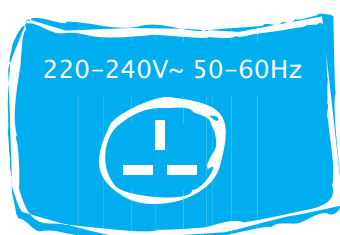

- 本機不是為體質、感覺或智力有障礙人士(包括小孩)或缺乏經驗及知識者使用，除非他們曾經接受負責安全人士的監督或指示，大人應指導小孩不可把玩電器。

The appliance is not to be used by persons (including children) with reduced physical, sensory or mental capabilities, or lack of experience and knowledge, unless they have been given supervision or instruction. Children being supervised not to play with the appliance.

- 請使用獨立插座。使用萬能插頭或拖板，容易發生危險。

Avoid using extension cord as it may overheat and casue fire.

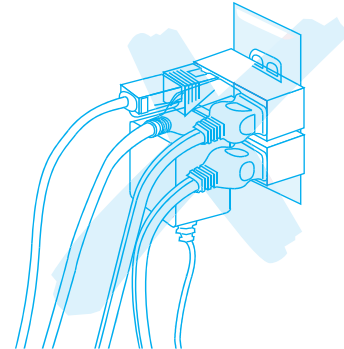

- 拔除插頭時不可拉扯電源線，必須緊握插頭，把插頭拔出。

Do not pull the power cord to disconnect from power source. Always grasp the plug to pull out.

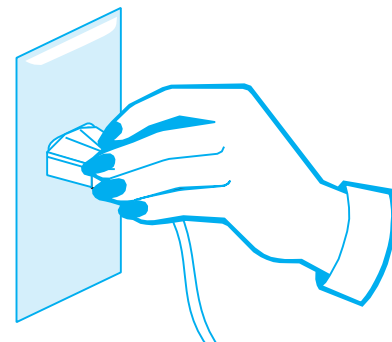

- 切勿將任何異物放入風扇內；或阻擋風扇出風口及入風口，皆因以上一切行為均可能導致風扇損壞。

Do not insert any objects into the Fan as it may cause an electric shock or damage. Do not block or tamper with the Fan in any manner while it is in operation.

- 非使用風扇時請拔除插頭，切斷電源。

Do not leave the Fan unattended. Always unplug the Fan Cooler when not in use.

- 警告：開/關鍵不應作為切斷電源的用途。

WARNING: The On/Off switch should not be used as the sole means of disconnecting power. Always unplug the power cord before servicing or moving the unit.

- 本風扇不適用於室外及作工業用途。

This Fan is intended for household use ONLY and not for industrial or outdoor use.

- 如須移動風扇，請先拔除插頭切斷電源。

Always disconnected the Fan from the power supply when moving it from one location to another.

-  本產品含有可回收材料，不可把本產品作為未分類廢物。請聯繫當地就近指定回收點。

 This product contains recyclable materials. Do not dispose this product as unsorted municipal waste. Please contact your local municipality for the nearest collection

- 不可在潮濕或有積水的環境使用，不可將風扇擺放於浴缸或大型容器上面。

The Fan is not intended for use in wet or damp locations. Never locate the Fan where it may fall into a bathtub or other water container.



- 切勿將風扇擺放在發熱源頭或火源附近。

Do not place the Fan near a source of heat or fire.

- 請保持清潔以維持風扇處於良好狀態（詳細請參閱清理及維護部份）。

Keep the Fan clean to maintain in good condition (refer to maintenance section).

- 移除網罩前，必須確保風扇已拔掉電源。

Ensure that the fan is switched off from the supply mains before removing the guard.

- 警告；清理前必須先拔除電源插頭。若電源線損壞，必須交由製造商或其代理指定維修服務中心檢查及修理。

WARNING: To avoid danger of electric shock, unplug from outlet when not in use and before cleaning. If the power cord is damaged, it must be replaced by the manufacturer, its service agent or similarly qualified persons in order to avoid hazard.

圖片只供參考，一切以實物為準
The picture is for reference only,
everything in kind shall prevail.

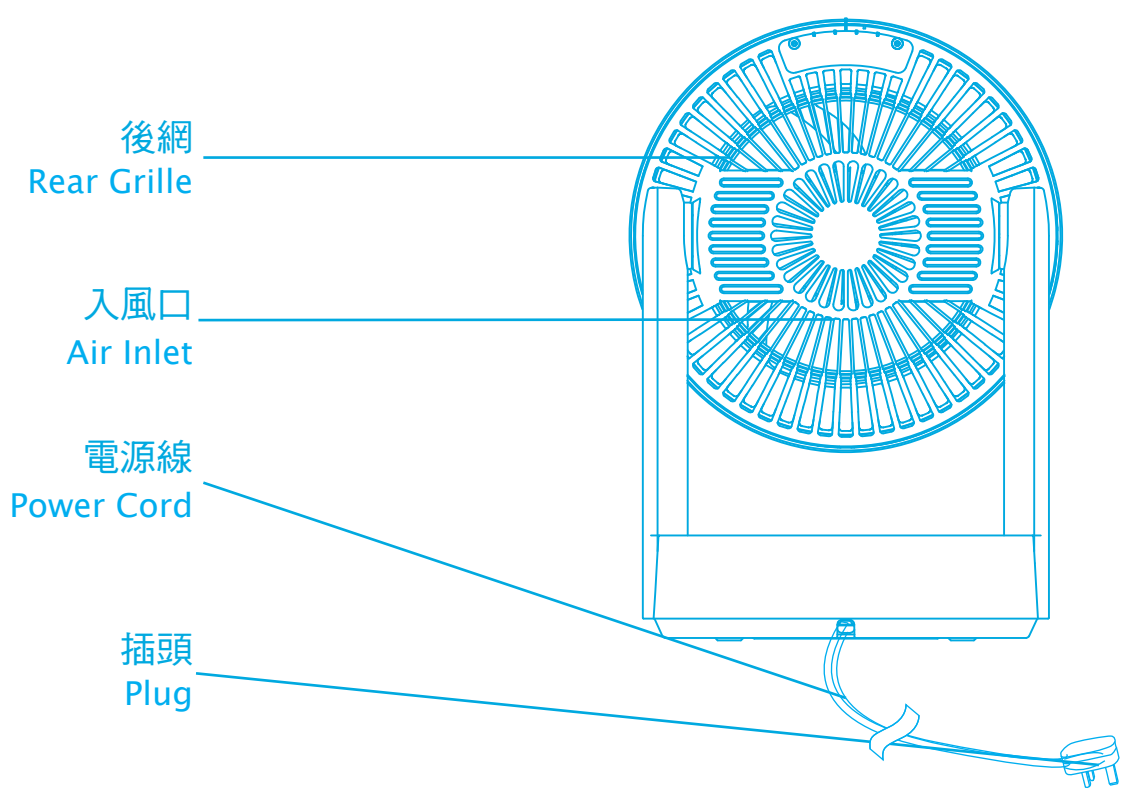
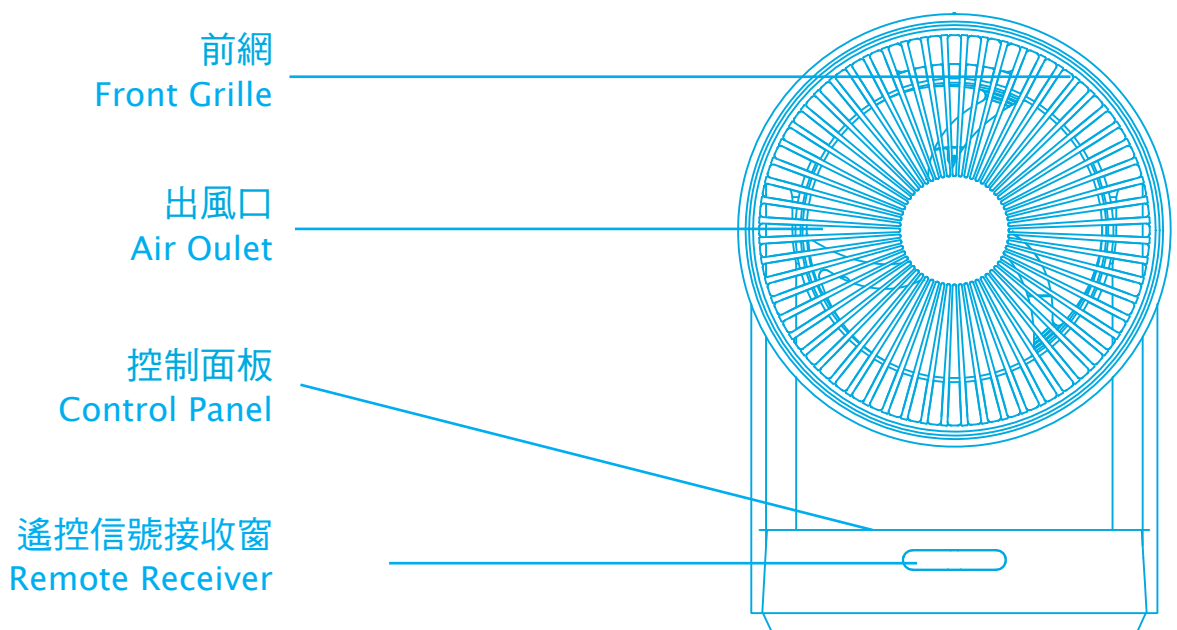

風扇可使用控制面板按鍵操控(如圖 1)，或改用遙控器操控。







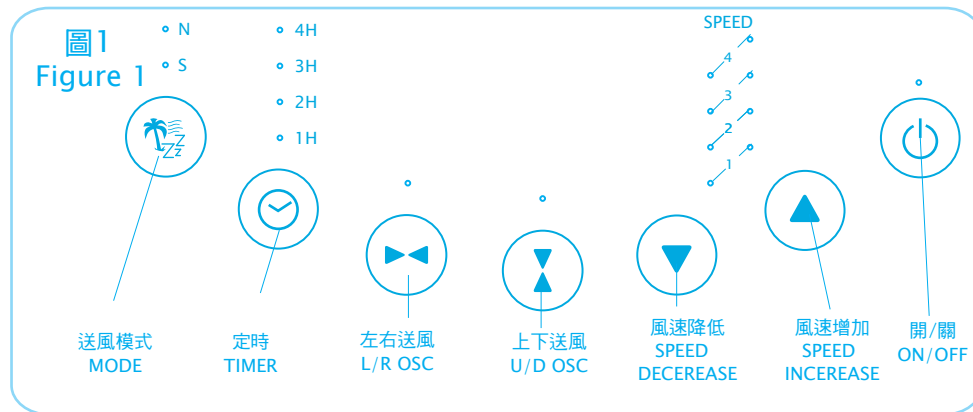

1. 將風扇擺放於穩固的平面上，將插頭插入交流電壓220-240V~，50-60Hz的獨立插座。
2. 開/關:按開/關鍵 ，電源指示燈亮起，風扇以低檔啟動。

The Fan may be operated by the control panel (as shown in Figure 1) or by your remote control.

1. Place the Fan on a stable and flat surface. Plug the Power Cord into an 220-240V~, 50-60Hz electrical outlet.
2. POWER: Turn the Fan ON by pressing the  key, power indicator light on, the Fan start at low speed.



圖片只供參考，一切以實物為準/The picture is for reference only, everything in kind shall prevail.

3. 風速: 按 ▲ 或 ▼ 鍵設定所需風速: 低、中、高、或超強。LED顯示燈將會顯示風速。
3. SPEED: Adjust the Fan speed to the desired level: Low, Medium, High or Gale by pressing ▲ or ▼ key. The speed setting is displayed on the LED light.
4. 上下送風: 按下上下送風鍵 ，風扇以自動上下搖擺模式送風。如欲停止自動上下搖擺送風，再按此鍵一次。
4. OSC(UP/DOWN): Press the  key to allow the Fan to UP/DOWN oscillate the wind direction. To stop the oscillation, press the button again.
5. 左右送風: 按下左右送風鍵  風扇以自動左右搖擺模式送風。如欲停止自動左右搖擺送風，再按此鍵一次。
5. OSC(LEFT/RIGHT): Press the  key to allow the Fan to LEFT/RIGHT oscillate the wind direction. To stop the oscillation, press the button again.
6. 定時設置: 按下定時設置鍵 ，選定4個不同的自動關機時間，分別由1至4小時，LED顯示燈將會亮起。
6. TIMER: Pressing the  key to set desired auto power off time, There are 4 time intervals, from 1-hour to 4-hour.
7. 送風模式: 按送風模式鍵 ，設定所需送風模式: 自然風、或睡眠風。LED顯示燈將會亮起。
7. MODE: Press the  key to set the Fan as Natural, or Sleep mode. The mode is displayed on the LED light.

1. 遙控器操作方式與機身按鍵操作方式相同。
2. 更換電池：使用一枚3伏特鋰電池。
1. All functions performed by the Remote Control work are identical to the Manual.
2. Battery replacement: Install one 3V Lithium battery.

警告

- 1) 請把電池放在兒童碰不到的地方，如果孩子吞下電池，需立即致電諮詢醫生。
- 2) 不要對電池進行充電或隨意棄置在有火源的地方。
- 3) 應保持電池存放於乾燥，陰涼的地方。
- 4) 以正確的方向插入電池。

 電池的處理 - 請按相關地區的法律規定處理曾經使用的電池。

WARNING

1. Keep batteries out of reach of children. Should a child swallow a battery, consult a doctor immediately.
2. Do not recharge or dispose in fire.
3. Keep in a dry and cool place.
4. Insert battery in right direction.

 Battery disposal - Please dispose the used battery per municipal or provincial law.

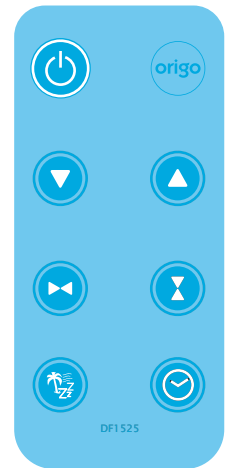
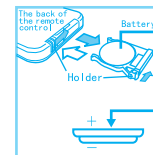
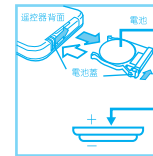

清理及維護

Maintenance

警告：不使用風扇時，經常保持拔除電源，及切勿將風扇浸於水或其他液體中。在清潔本風扇前，先將風扇關掉及把電源線從插座拔出。

WARNING: ALWAYS UNPLUG THE POWER CORD BEFORE MOVING OR SERVICING. DO NOT IMMERSE THE FAN IN WATER! BEFORE CLEANING, MAKE SURE THAT THE UNIT HAS BEEN SWITCHED OFF AND IT IS UNPLUGGED FROM THE MAIN OUTLET.

外殼：清理時切勿將風扇浸於水或其他液體中。使用濕潤軟布抹擦清潔，頑固污垢可用軟布沾上含肥皂的溫水抹擦。

House: Clean the outside of the Fan with a soft cloth, to remove presistent dirt or grime wipe down with a cloth that has been dampened with warm soapy water.

注意：切勿使用含有腐蝕性的清潔劑或溶液清理風扇。

CAUTION: Do NOT use gasoline, benzene, thinner, harsh cleaners, etc., as they will damage the Fan. NEVER use ALCOHOL or any other SOLVENTS.

儲存：連同使用說明，把風扇存放於清涼及乾爽的地方。

STORAGE: Store the Fan with these instructions in the original box in a cool and dry place.

型號 Model Number	DF1525
電源 Power Supply	220-240V~ 50-60Hz
額定功率 Rated Power	35W
產品尺寸 Product Dimension	260 x 252 x 372 mm (約/Approx.)

源澤地圖

Origin Map

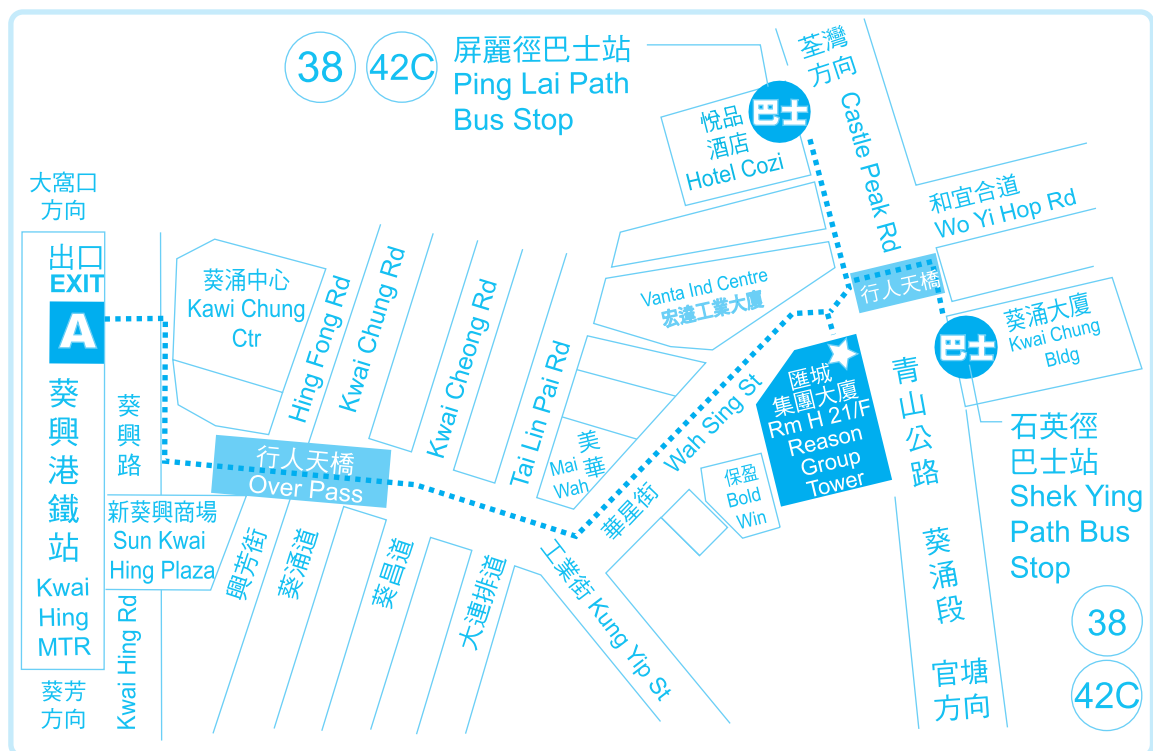

辦公時間

10:30am - 12:30pm (星期一至五)
02:30pm - 05:30pm (星期一至五)
10:30am - 12:30pm (星期六)
(星期日及公眾假期休息)

OFFICE HOURS

10:30am - 12:30pm (Mon to Fri)
02:30pm - 05:30pm (Mon to Fri)
10:30am - 12:30pm (Saturday)
(Closed on Sunday and Holiday)

產品保用証(一年自攜服務)

立體搖擺座檯扇
3D twister desk fan

origo

產品: 立體搖擺座檯扇

型號: DF1525

此產品由購買日期起計算，本公司將根據下列條款及細則，提供一年保養服務(商業用享為3個月):

1. 於購買後一年內，經本公司技術員判斷為正常運作下損壞之產品，可獲免費維修和/或零件更換。
 2. 以下情況不被包括在保養範圍內：
 - 若產品是因為濫用、錯誤使用、疏忽及/或意外而遭致損壞；
 - 未經授權之自行處理、維修及/或改裝；
 - 任何遙控、機殼、面蓋、扇葉，以及配件。
 3. 需要檢查或維修時，請將產品送往本公司服務中心，並於修理妥當後自行取回。
 4. 更換後之任何損壞零件，均屬本公司所有。
 5. 本保養服務只適用於香港特別行政區。
 6. 顧客必須同時出示零售商之正式發票，方可得到免費維修服務。
- *** 額外3個月保用：凡於購買產品後10天內完成網上登記，即可免費延長保用期3個月，即15個月免費保用(商業用途除外)。請即登入網站: www.origo.hk

服務中心

源澤市務有限公司

香港新界葵涌青山公路403號(近華星街12號)匯城集團大廈21樓H室

電話: 2156 8238

www.origo.hk

www.origo.hk



Find us on



Warranty Card(1 year carry-in)

Item : 3D Twister Desk Fan

Model : DF1525

This product is warranted for 1 year (commercial use for 3 months) from the date of purchase under the following conditions:

1. For any defect, in the judgment of our technician, if it is caused under normal use, we are responsible for repairing the product, and/or replacing parts at free of charge.
2. This warranty DOES NOT apply to:
 - If the product has been damaged through abuse, misuse, negligence or accidents;
 - Unauthorized repair, alteration/modification;
 - The remote control, housing, cover, blade or accessories.
3. The customer is requested to bring the unit to and from our Service Centre whenever service is needed.
4. Any defective parts, which had been replaced, shall be of our property.
5. This warranty is valid in H.K.S.A.R. only.
6. Please show the Invoice to get free service.

***Extra 3 months warranty: just complete Online Warranty Registration within 10 days from the date of receipt, free warranty will be extended to 15 months (not applicable to commercial use). Please enter our website: www.origo.hk

Service Centre

ORIGIN MARKETING LIMITED

Unit H, 21/F., Reason Group Tower (nearby 12 Wah Sing Street), 403 Castle Peak Road, Kwai Chung, N.T., Hong Kong.

Tel: 2156 8238

www.origo.hk

www.origo.hk



Find us on

